

PHOS 85 outdoor pro 1-10V is a projector for professional indoor and outdoor use with uncompromising technical features: IP65 protective housing, 1–10 V control, high efficiency, durable, extremely reliable components. The projector is particularly suitable for use as a safety system in an industrial environment or for demanding outdoor lighting installations - at any time of the year and in any weather! The projection motif (gobo) can be changed without tools.

Construction

housing: anodized aluminum, stainless steel, powder coated
 weight (standard equipment): 4.1 kg | 9.04 lbs
 On / Off switch: not available
 IP-rating of the housing IP 65

Operating Conditions

application area outdoor locations, humid interiors
 ambient temperature: -30°C - +35°C
 cooling: active, with a fan, 26 dBA

Light Source and Optics

light source: High Power LED, 80 W
 luminous flux of the projector: 4,729 lumens
 efficiency 55 lumens / watt
 colour temperature: 6,300 – 6,700 K
 colour rendering index: Ra >70
 estimated lifetime of the LED (L70): 35,000 operating hours
 projection lens: Standard Lens, f=85 mm (included)
 gobo size / image size: Ø 50.0 mm / Ø 40.0 mm
 photobiological safety (ICE62471-5:2015, EN62471-5:2015): RG-2

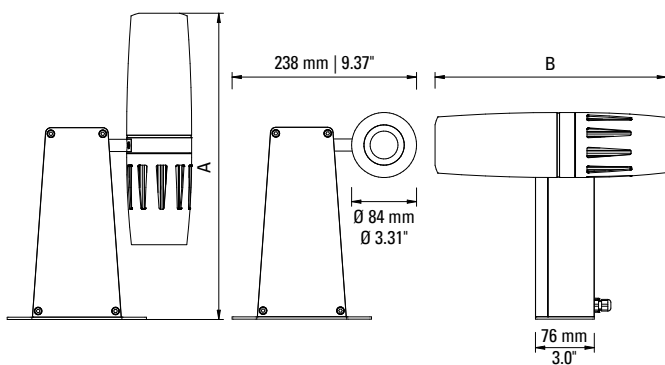

Projection Lens	Height A	Width B
Extra Wide Angle, f=45 mm	417 mm 16.4 "	322 mm 12.7 "
Wide Angle, f=63 mm	394 mm 15.5 "	298 mm 11.7 "
Standard, f=85 mm	394 mm 15.5 "	298 mm 11.7 "
Telephoto, f=135 mm	465 mm 18.3 "	370 mm 14.6 "

Electrical Specifications

input voltage: 220 - 240V AC, 50/60 Hz
 power consumption: 86 W
 power factor: 0.95 cos. φ
 electrical protection class: I
 max. number of devices per circuit breaker B16A/C16A: 15/25
 lighting control: 1–10 V

Item No.: 20850310 (white), 20850320 (black), 20850330 (silver)

Additional Accessories: individual glass gobo according to your digital artwork, Extra Wide Angle Lens, f=45 mm, Wide Angle Lens, f=63 mm, Telephoto Lens, f=135 mm



PHOS 85 outdoor pro 1-10V – Photometric Diagrams

PHOS 85, Extra Wide Angle Lens, f = 45 mm, 48°

illuminance [lux]

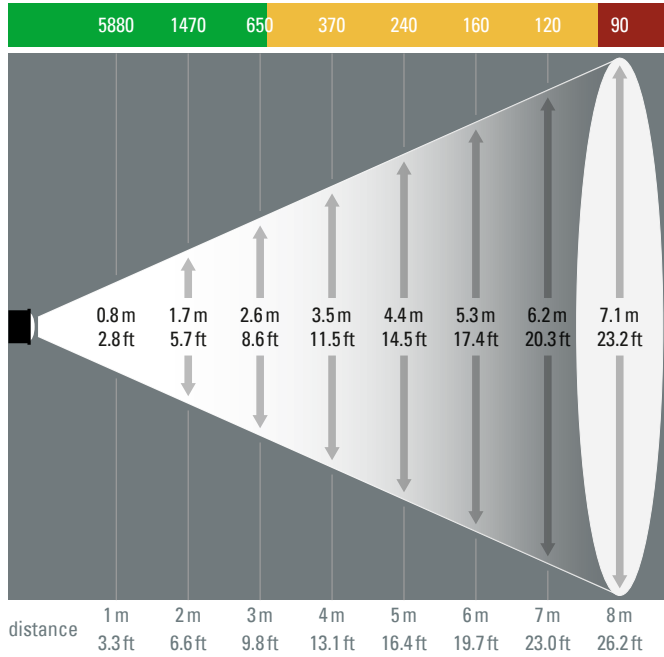

PHOS 85, Wide Angle Lens, f = 63 mm, 35°

illuminance [lux]

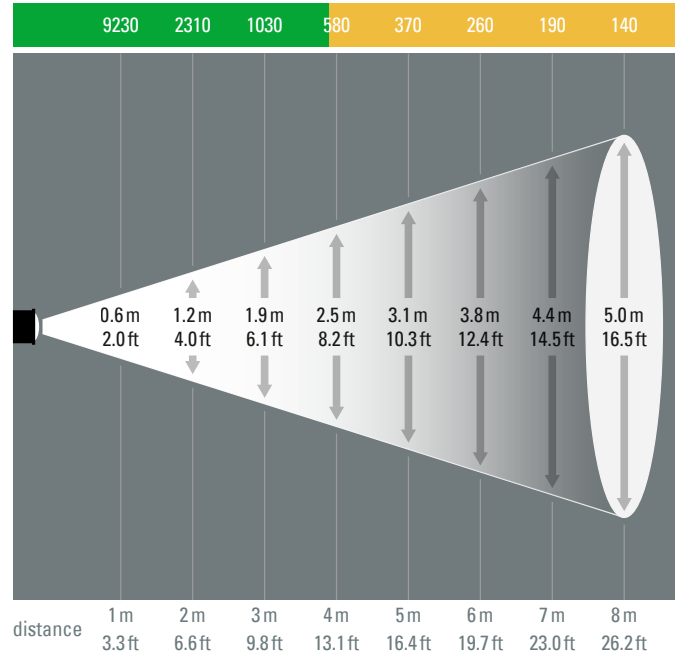

PHOS 85, Standard Lens, f = 85 mm, 26°

illuminance [lux]

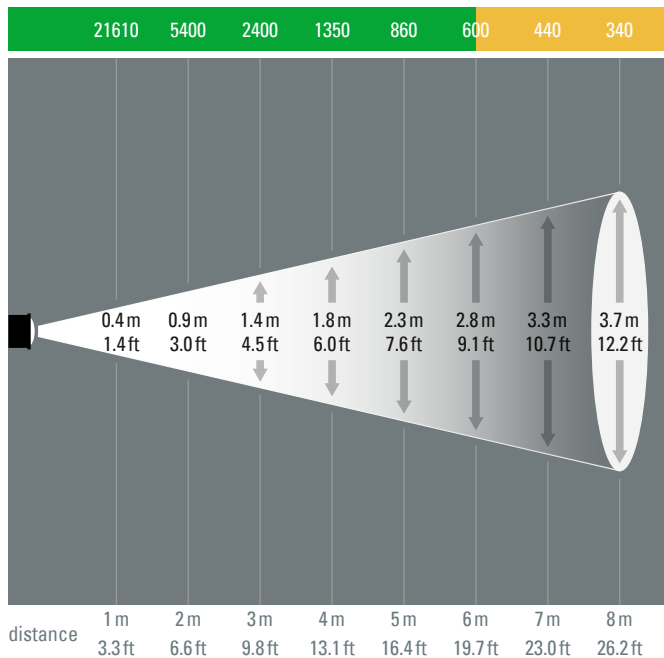

PHOS 85, Telephoto Lens, f = 135 mm, 17°

illuminance [lux]

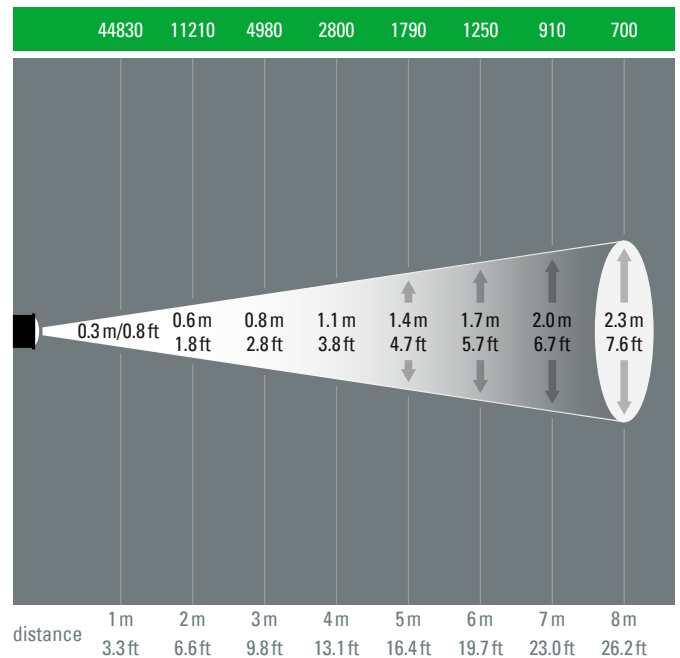

Brightness Colour Coding:

- = with standard room lighting, suitable for coloured motifs
- = in low-light rooms, for motifs without colour
- = recommended only in darkened rooms

- The results shown are approximate values. The result may differ slightly in reality.
- The projection sizes indicate the maximum diameter that can be projected with a Ø 40 mm image.
- The projection motif is circular and fills the image area of the gobo. Other objects, e.g. rectangles or texts are fitted into the circular projection area.
- The projection is at right angles to the projection surface.

Detailed projection calculator at: www.derksen.de

derksen®
lichttechnik

Derksen Lichttechnik GmbH
Johannes-Rau-Allee 4
45889 Gelsenkirchen
Germany

Tel.: +49 209 98070-0
info@derksen.de
www.derksen.de